

Slider NSW/NSA

Robust zinc plated steel slider with ball bearings, self-centering heads with wipers, longitudinal seals to protect the internal components and a top sealing strip to prevent accidental tampering of the fixed rollers. The slider body is accurately finished with matte longitudinal edge chamfer and a shining ground flat surface. It is available for all sizes, configurable with up to six rollers depending on the load requirement.



Standard sliders are supplied with rollers with 2Z steel disc seals. For dusty environment and splash-proof applications, 2RS rubber seal rollers are available.

All NSA-sliders, which are made for rail type K, have rollers with circular cross profile. The main load direction should always be on the largest number of the slider-wheels and those wheels should always run on the V-shaped raceway of the K-Rail. So for a typical slider with 3 wheels, the two outer wheels should carry the majority of the load and run in the V-shape and the third (middle) wheel should run on the flat raceway in the K-Rail.

All NSW/NSA sliders have wipers assembled and the wipers for K-Rails are adapted to work on the two different raceway shapes.

Dimensions in mm.

Material: DIN 11SMnPb28. Zinc-plated according to ISO 2081.

Max. Radial Load Capacity (N): 15,000 (per slider)

Temperature range (°C): -20 to +120

General Data

Designation	Size	Max. Speed (m/s)	Max. Acceleration (m/s)	Roller type	Number of rollers
NSW18-3-2RS	18	3	10	CPA18-CPN18	3
NSW18-3-2Z	18	3	10	CPA18-CPN18	3
NSW18-4A-2RS	18	3	10	CPA18	4
NSW18-4A-2Z	18	3	10	CPA18	4
NSW18-4B-2RS	18	3	10	CPA18	4
NSW18-4B-2Z	18	3	10	CPA18	4
NSW18-5-2RS	18	3	10	CPA18	5
NSW18-5-2Z	18	3	10	CPA18	5
NSW18-6A-2RS	18	3	10	CPA18	6
NSW18-6A-2Z	18	3	10	CPA18	6
NSW18-6B-2RS	18	3	10	CPA18	6
NSW18-6B-2Z	18	3	10	CPA18	6
NSW28-3-2RS	28	5	15	CPA28-CPN28	3
NSW28-3-2Z	28	5	15	CPA28-CPN28	3
NSW28-4A-2RS	28	5	15	CPA28	4
NSW28-4A-2Z	28	5	15	CPA28	4
NSW28-4B-2RS	28	5	15	CPA28	4
NSW28-4B-2Z	28	5	15	CPA28	4
NSW28-5-2RS	28	5	15	CPA28	5
NSW28-5-2Z	28	5	15	CPA28	5
NSW28-6A-2RS	28	5	15	CPA28	6
NSW28-6A-2Z	28	5	15	CPA28	6
NSW28-6B-2RS	28	5	15	CPA28	6
NSW28-6B-2Z	28	5	15	CPA28	6
NSW43-3-2RS	43	7	15	CPA43-CPN43	3
NSW43-3-2Z	43	7	15	CPA43-CPN43	3
NSW43-4A-2RS	43	7	15	CPA43	4
NSW43-4A-2Z	43	7	15	CPA43	4
NSW43-4B-2RS	43	7	15	CPA43	4
NSW43-4B-2Z	43	7	15	CPA43	4
NSW43-5-2RS	43	7	15	CPA43	5
NSW43-5-2Z	43	7	15	CPA43	5
NSW43-6A-2RS	43	7	15	CPA43	6
NSW43-6A-2Z	43	7	15	CPA43	6
NSW43-6B-2RS	43	7	15	CPA43	6
NSW43-6B-2Z	43	7	15	CPA43	6
NSA43-3-2RS	43	7	15	CRPA43-CRPN43	3
NSA43-3-2Z	43	7	15	CRPA43-CRPN43	3
NSA43-4A-2RS	43	7	15	CRPA43	4
NSA43-4A-2Z	43	7	15	CRPA43	4
NSA43-4B-2RS	43	7	15	CRPA43	4
NSA43-4B-2Z	43	7	15	CRPA43	4
NSA43-5-2RS	43	7	15	CRPA43	5

Designation	Size	Max. Speed (m/s)	Max. Acceleration (m/s)	Roller type	Number of rollers
NSA43-5-2Z	43	7	15	CRPA43	5
NSA43-6A-2RS	43	7	15	CRPA43	6
NSA43-6A-2Z	43	7	15	CRPA43	6
NSA43-6B-2RS	43	7	15	CRPA43	6
NSA43-6B-2Z	43	7	15	CRPA43	6
NSW63-3-2ZR	63	9	20	CPA63	3
NSW63-4A-2ZR	63	9	20	CPA63	4
NSW63-4B-2ZR	63	9	20	CPA63	4
NSW63-5-2ZR	63	9	20	CPA63	5
NSW63-6A-2ZR	63	9	20	CPA63	6
NSW63-6B-2ZR	63	9	20	CPA63	6
NSA63-3-2ZR	63	9	20	CRPA63	3
NSA63-4A-2ZR	63	9	20	CRPA63	4
NSA63-4B-2ZR	63	9	20	CRPA63	4
NSA63-5-2ZR	63	9	20	CRPA63	5
NSA63-6A-2ZR	63	9	20	CRPA63	6
NSA63-6B-2ZR	63	9	20	CRPA63	6

Designation	Number of Fixing Holes
NSW18-3-2RS	4
NSW18-3-2Z	4
NSW18-4A-2RS	2
NSW18-4A-2Z	2
NSW18-4B-2RS	2
NSW18-4B-2Z	2
NSW18-5-2RS	4
NSW18-5-2Z	4
NSW18-6A-2RS	3
NSW18-6A-2Z	3
NSW18-6B-2RS	3
NSW18-6B-2Z	3
NSW28-3-2RS	4
NSW28-3-2Z	4
NSW28-4A-2RS	2
NSW28-4A-2Z	2
NSW28-4B-2RS	2
NSW28-4B-2Z	2
NSW28-5-2RS	4
NSW28-5-2Z	4
NSW28-6A-2RS	3
NSW28-6A-2Z	3
NSW28-6B-2RS	3
NSW28-6B-2Z	3
NSW43-3-2RS	4
NSW43-3-2Z	4

Designation	Number of Fixing Holes
NSW43-4A-2RS	2
NSW43-4A-2Z	2
NSW43-4B-2RS	2
NSW43-4B-2Z	2
NSW43-5-2RS	4
NSW43-5-2Z	4
NSW43-6A-2RS	3
NSW43-6A-2Z	3
NSW43-6B-2RS	3
NSW43-6B-2Z	3
NSA43-3-2RS	4
NSA43-3-2Z	4
NSA43-4A-2RS	2
NSA43-4A-2Z	2
NSA43-4B-2RS	2
NSA43-4B-2Z	2
NSA43-5-2RS	4
NSA43-5-2Z	4
NSA43-6A-2RS	3
NSA43-6A-2Z	3
NSA43-6B-2RS	3
NSA43-6B-2Z	3
NSW63-3-2ZR	4+4
NSW63-4A-2ZR	5
NSW63-4B-2ZR	5
NSW63-5-2ZR	6
NSW63-6A-2ZR	7
NSW63-6B-2ZR	7
NSA63-3-2ZR	4+4
NSA63-4A-2ZR	5
NSA63-4B-2ZR	5
NSA63-5-2ZR	6
NSA63-6A-2ZR	7
NSA63-6B-2ZR	7

Dimensions

Size 18 - 28 - 43
(Use only the 2 fixing holes type 1 or 2)

NSW/NSA...3

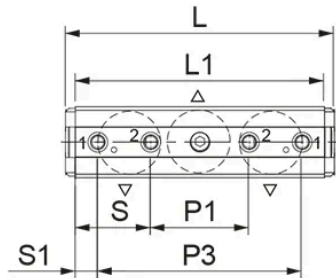

Size 63
(Use only the 4 fixing holes type 1 or 2)

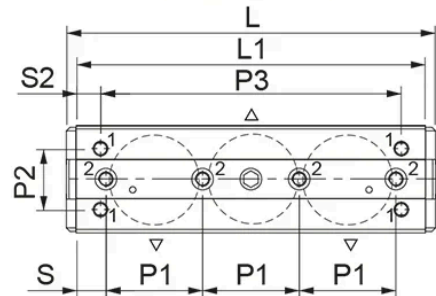

Configuration A

NSW/NSA...4

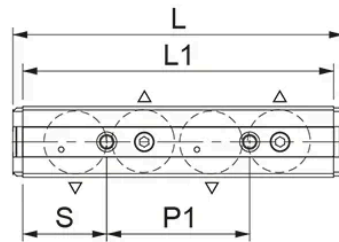

Configuration B

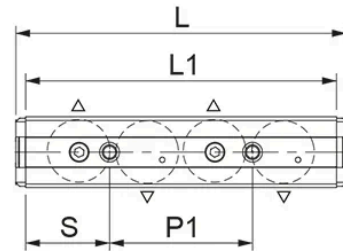

NSW/NSA...5

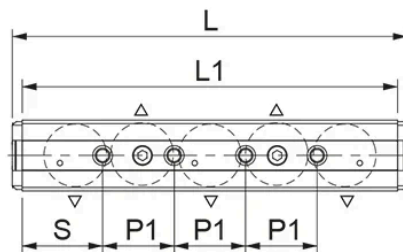

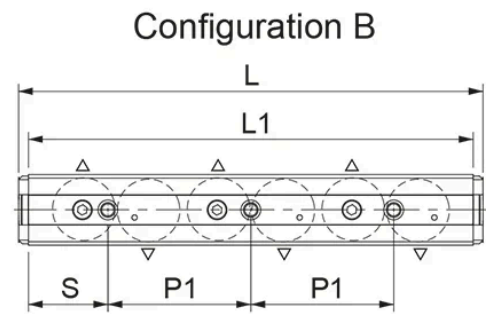
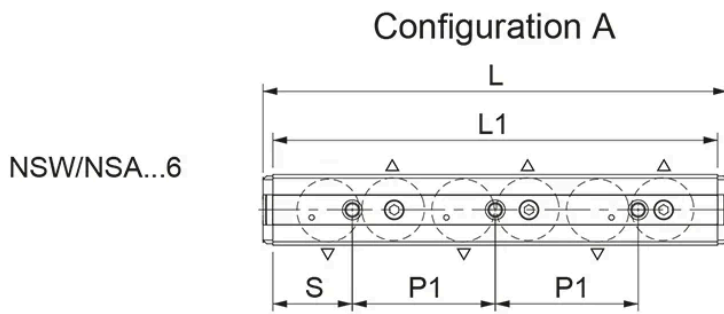

NSW-slider with prismatic rollers
for use in T- and U-rails

NSA-slider with crowned rollers
for use in K-rails

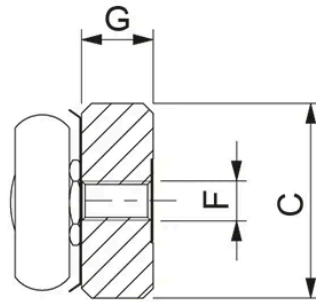
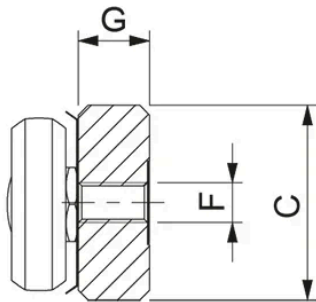

Designation	L1	L	C	G	F	P1	P2	P3	S
NSW18-3-2RS	70	78	16	7.2	M5	20	-	52	25
NSW18-3-2Z	70	78	16	7.2	M5	20	-	52	25
NSW18-4A-2RS	92	100	16	7.2	M5	40	-	-	26
NSW18-4A-2Z	92	100	16	7.2	M5	40	-	-	26
NSW18-4B-2RS	92	100	16	7.2	M5	40	-	-	26
NSW18-4B-2Z	92	100	16	7.2	M5	40	-	-	26
NSW18-5-2RS	112	120	16	7.2	M5	20	-	-	26
NSW18-5-2Z	112	120	16	7.2	M5	20	-	-	26
NSW18-6A-2RS	132	140	16	7.2	M5	40	-	-	26
NSW18-6A-2Z	132	140	16	7.2	M5	40	-	-	26
NSW18-6B-2RS	132	140	16	7.2	M5	40	-	-	26
NSW18-6B-2Z	132	140	16	7.2	M5	40	-	-	26
NSW28-3-2RS	97	108	24.9	9.7	M5	35	-	78	31
NSW28-3-2Z	97	108	24.9	9.7	M5	35	-	78	31
NSW28-4A-2RS	117	128	24.9	9.7	M5	50	-	-	33.5
NSW28-4A-2Z	117	128	24.9	9.7	M5	50	-	-	33.5
NSW28-4B-2RS	117	128	24.9	9.7	M5	50	-	-	33.5
NSW28-4B-2Z	117	128	24.9	9.7	M5	50	-	-	33.5
NSW28-5-2RS	142	153	24.9	9.7	M5	25	-	-	33.5
NSW28-5-2Z	142	153	24.9	9.7	M5	25	-	-	33.5
NSW28-6A-2RS	167	178	24.9	9.7	M5	50	-	-	33.5

Designation	L1	L	C	G	F	P1	P2	P3	S
NSW28-6A-2Z	167	178	24.9	9.7	M5	50	-	-	33.5
NSW28-6B-2RS	167	178	24.9	9.7	M5	50	-	-	33.5
NSW28-6B-2Z	167	178	24.9	9.7	M5	50	-	-	33.5
NSW43-3-2RS	139	150	39.5	14.5	M8	55	-	114	42
NSW43-3-2Z	139	150	39.5	14.5	M8	55	-	114	42
NSW43-4A-2RS	174	185	39.5	14.5	M8	80	-	-	47
NSW43-4A-2Z	174	185	39.5	14.5	M8	80	-	-	47
NSW43-4B-2RS	174	185	39.5	14.5	M8	80	-	-	47
NSW43-4B-2Z	174	185	39.5	14.5	M8	80	-	-	47
NSW43-5-2RS	210	221	39.5	14.5	M8	40	-	-	45
NSW43-5-2Z	210	221	39.5	14.5	M8	40	-	-	45
NSW43-6A-2RS	249	260	39.5	14.5	M8	80	-	-	44.5
NSW43-6A-2Z	249	260	39.5	14.5	M8	80	-	-	44.5
NSW43-6B-2RS	249	260	39.5	14.5	M8	80	-	-	44.5
NSW43-6B-2Z	249	260	39.5	14.5	M8	80	-	-	44.5
NSA43-3-2RS	139	150	39.5	14.5	M8	55	-	114	42
NSA43-3-2Z	139	150	39.5	14.5	M8	55	-	114	42
NSA43-4A-2RS	174	185	39.5	14.5	M8	80	-	-	47
NSA43-4A-2Z	174	185	39.5	14.5	M8	80	-	-	47
NSA43-4B-2RS	174	185	39.5	14.5	M8	80	-	-	47
NSA43-4B-2Z	174	185	39.5	14.5	M8	80	-	-	47
NSA43-5-2RS	210	221	39.5	14.5	M8	40	-	-	45
NSA43-5-2Z	210	221	39.5	14.5	M8	40	-	-	45
NSA43-6A-2RS	249	260	39.5	14.5	M8	80	-	-	44.5
NSA43-6A-2Z	249	260	39.5	14.5	M8	80	-	-	44.5
NSA43-6B-2RS	249	260	39.5	14.5	M8	80	-	-	44.5
NSA43-6B-2Z	249	260	39.5	14.5	M8	80	-	-	44.5
NSW63-3-2ZR	195	206	60	20.2	M8	54	34	168	16.5
NSW63-4A-2ZR	250	261	60	20.2	M8	54	-	-	17
NSW63-4B-2ZR	250	261	60	20.2	M8	54	-	-	17
NSW63-5-2ZR	305	316	60	20.2	M8	54	-	-	17.5
NSW63-6A-2ZR	360	371	60	20.2	M8	54	-	-	18
NSW63-6B-2ZR	360	371	60	20.2	M8	54	-	-	18
NSA63-3-2ZR	195	206	60	20.2	M8	54	34	168	16.5
NSA63-4A-2ZR	250	261	60	20.2	M8	54	-	-	17
NSA63-4B-2ZR	250	261	60	20.2	M8	54	-	-	17
NSA63-5-2ZR	305	316	60	20.2	M8	54	-	-	17.5
NSA63-6A-2ZR	360	371	60	20.2	M8	54	-	-	18
NSA63-6B-2ZR	360	371	60	20.2	M8	54	-	-	18

Designation	S1	S2
NSW18-3-2RS	9	-
NSW18-3-2Z	9	-
NSW18-4A-2RS	-	-
NSW18-4A-2Z	-	-

Designation	S1	S2
NSW18-4B-2RS	-	-
NSW18-4B-2Z	-	-
NSW18-5-2RS	-	-
NSW18-5-2Z	-	-
NSW18-6A-2RS	-	-
NSW18-6A-2Z	-	-
NSW18-6B-2RS	-	-
NSW18-6B-2Z	-	-
NSW28-3-2RS	9.5	-
NSW28-3-2Z	9.5	-
NSW28-4A-2RS	-	-
NSW28-4A-2Z	-	-
NSW28-4B-2RS	-	-
NSW28-4B-2Z	-	-
NSW28-5-2RS	-	-
NSW28-5-2Z	-	-
NSW28-6A-2RS	-	-
NSW28-6A-2Z	-	-
NSW28-6B-2RS	-	-
NSW28-6B-2Z	-	-
NSW43-3-2RS	12.5	-
NSW43-3-2Z	12.5	-
NSW43-4A-2RS	-	-
NSW43-4A-2Z	-	-
NSW43-4B-2RS	-	-
NSW43-4B-2Z	-	-
NSW43-5-2RS	-	-
NSW43-5-2Z	-	-
NSW43-6A-2RS	-	-
NSW43-6A-2Z	-	-
NSW43-6B-2RS	-	-
NSW43-6B-2Z	-	-
NSA43-3-2RS	12.5	-
NSA43-3-2Z	12.5	-
NSA43-4A-2RS	-	-
NSA43-4A-2Z	-	-
NSA43-4B-2RS	-	-
NSA43-4B-2Z	-	-
NSA43-5-2RS	-	-
NSA43-5-2Z	-	-
NSA43-6A-2RS	-	-
NSA43-6A-2Z	-	-
NSA43-6B-2RS	-	-
NSA43-6B-2Z	-	-
NSW63-3-2ZR	-	13.5

Designation	S1	S2
NSW63-4A-2ZR	-	-
NSW63-4B-2ZR	-	-
NSW63-5-2ZR	-	-
NSW63-6A-2ZR	-	-
NSW63-6B-2ZR	-	-
NSA63-3-2ZR	-	13.5
NSA63-4A-2ZR	-	-
NSA63-4B-2ZR	-	-
NSA63-5-2ZR	-	-
NSA63-6A-2ZR	-	-
NSA63-6B-2ZR	-	-

Load & Weight

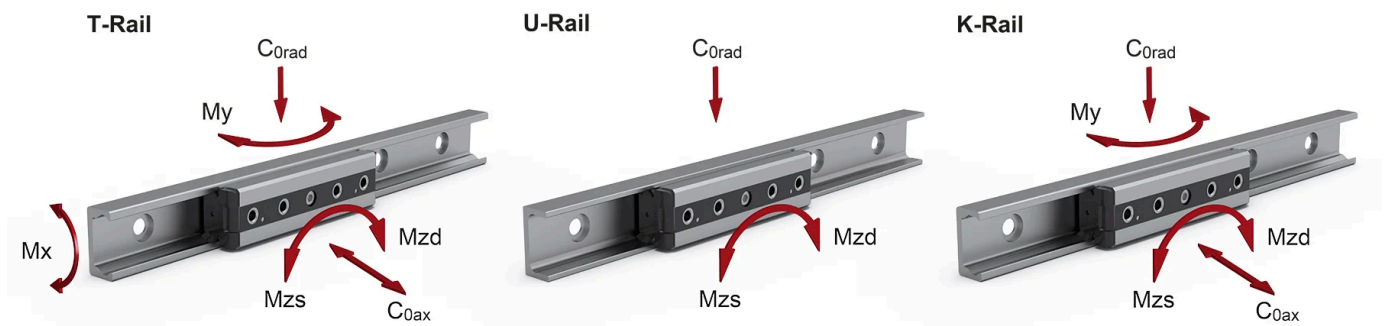

The load capacities in the following tables each apply for one slider. When using the slider in U-rails (floating bearing rails) the values are $C_{0ax} = 0$, $M_x = 0$ and $M_y = 0$. When using the sliders in K-rails (compensation rails) the value is: $M_x = 0$.

Designation	C (N)	C_{0rad} (N)	C_{0ax} (N)	M_x (Nm)	M_y (Nm)
NSW18-3-2RS	1530	820	260	1.5	4.7
NSW18-3-2Z	1530	820	260	1.5	4.7
NSW18-4A-2RS	1530	820	300	2.8	7
NSW18-4A-2Z	1530	820	300	2.8	7
NSW18-4B-2RS	1530	820	300	2.8	7
NSW18-4B-2Z	1530	820	300	2.8	7
NSW18-5-2RS	1830	975	360	2.8	9.4
NSW18-5-2Z	1830	975	360	2.8	9.4
NSW18-6A-2RS	1830	975	440	3.3	11.8
NSW18-6A-2Z	1830	975	440	3.3	11.8
NSW18-6B-2RS	1830	975	440	3.3	11.8
NSW18-6B-2Z	1830	975	440	3.3	11.8
NSW28-3-2RS	4260	2170	640	6.2	16
NSW28-3-2Z	4260	2170	640	6.2	16
NSW28-4A-2RS	4260	2170	750	11.5	21.7
NSW28-4A-2Z	4260	2170	750	11.5	21.7
NSW28-4B-2RS	4260	2170	750	11.5	21.7
NSW28-4B-2Z	4260	2170	750	11.5	21.7
NSW28-5-2RS	5065	2580	900	11.5	29

Designation	C (N)	C0rad (N)	C0ax (N)	Mx (Nm)	My (Nm)
NSW28-5-2Z	5065	2580	900	11.5	29
NSW28-6A-2RS	5065	2580	1070	13.7	36.2
NSW28-6A-2Z	5065	2580	1070	13.7	36.2
NSW28-6B-2RS	5065	2580	1070	13.7	36.2
NSW28-6B-2Z	5065	2580	1070	13.7	36.2
NSW43-3-2RS	12280	5500	1570	23.6	60
NSW43-3-2Z	12280	5500	1570	23.6	60
NSW43-4A-2RS	12280	5500	1855	43.6	81.5
NSW43-4A-2Z	12280	5500	1855	43.6	81.5
NSW43-4B-2RS	12280	5500	1855	43.6	81.5
NSW43-4B-2Z	12280	5500	1855	43.6	81.5
NSW43-5-2RS	14675	6540	2215	43.6	108.6
NSW43-5-2Z	14675	6540	2215	43.6	108.6
NSW43-6A-2RS	14675	6540	2645	52	135.8
NSW43-6A-2Z	14675	6540	2645	52	135.8
NSW43-6B-2RS	14675	6540	2645	52	135.8
NSW43-6B-2Z	14675	6540	2645	52	135.8
NSA43-3-2RS	12280	5100	1320	0	50.4
NSA43-3-2Z	12280	5100	1320	0	50.4
NSA43-4A-2RS	12280	5100	1320	0	54.3
NSA43-4A-2Z	12280	5100	1320	0	54.3
NSA43-4B-2RS	12280	5100	1320	0	54.3
NSA43-4B-2Z	12280	5100	1320	0	54.3
NSA43-5-2RS	14675	6065	1570	0	108.7
NSA43-5-2Z	14675	6065	1570	0	108.7
NSA43-6A-2RS	14675	6065	1570	0	108.7
NSA43-6A-2Z	14675	6065	1570	0	108.7
NSA43-6B-2RS	14675	6065	1570	0	108.7
NSA43-6B-2Z	14675	6065	1570	0	108.7
NSW63-3-2ZR	30750	12500	6000	125	271
NSW63-4A-2ZR	30750	12500	7200	250	413
NSW63-4B-2ZR	30750	12500	7200	250	413
NSW63-5-2ZR	36600	15000	8500	250	511
NSW63-6A-2ZR	36600	15000	10000	350	689
NSW63-6B-2ZR	36600	15000	10000	350	689
NSA63-3-2ZR	30750	11550	5045	0	235
NSA63-4A-2ZR	30750	11550	5045	0	294
NSA63-4B-2ZR	30750	11550	5045	0	294
NSA63-5-2ZR	36600	13745	6000	0	589
NSA63-6A-2ZR	36600	13745	6000	0	589
NSA63-6B-2ZR	36600	13745	6000	0	589

Designation	Mzd (Nm)	Mzs (Nm)	Weight (kg)
NSW18-3-2RS	8.2	8.2	0.096
NSW18-3-2Z	8.2	8.2	0.096

Designation	Mzd (Nm)	Mzs (Nm)	Weight (kg)
NSW18-4A-2RS	8.2	24.7	0.096
NSW18-4A-2Z	8.2	24.7	0.096
NSW18-4B-2RS	24.7	8.2	0.11
NSW18-4B-2Z	24.7	8.2	0.11
NSW18-5-2RS	24.7	24.7	0.11
NSW18-5-2Z	24.7	24.7	0.11
NSW18-6A-2RS	24.7	41.1	0.138
NSW18-6A-2Z	24.7	41.1	0.138
NSW18-6B-2RS	41.1	24.7	0.138
NSW18-6B-2Z	41.1	24.7	0.138
NSW28-3-2RS	27.2	27.2	0.23
NSW28-3-2Z	27.2	27.2	0.23
NSW28-4A-2RS	27.2	81.7	0.29
NSW28-4A-2Z	27.2	81.7	0.29
NSW28-4B-2RS	81.7	27.2	0.29
NSW28-4B-2Z	81.7	27.2	0.29
NSW28-5-2RS	81.7	81.7	0.35
NSW28-5-2Z	81.7	81.7	0.35
NSW28-6A-2RS	81.7	136.1	0.42
NSW28-6A-2Z	81.7	136.1	0.42
NSW28-6B-2RS	136.1	81.7	0.42
NSW28-6B-2Z	136.1	81.7	0.42
NSW43-3-2RS	104.5	104.5	0.8
NSW43-3-2Z	104.5	104.5	0.8
NSW43-4A-2RS	104.5	313.5	1.02
NSW43-4A-2Z	104.5	313.5	1.02
NSW43-4B-2RS	313.5	104.5	1.02
NSW43-4B-2Z	313.5	104.5	1.02
NSW43-5-2RS	313.5	313.5	1.24
NSW43-5-2Z	313.5	313.5	1.24
NSW43-6A-2RS	313.5	522.5	1.47
NSW43-6A-2Z	313.5	522.5	1.47
NSW43-6B-2RS	522.5	313.5	1.47
NSW43-6B-2Z	522.5	313.5	1.47
NSA43-3-2RS	96.9	96.9	0.8
NSA43-3-2Z	96.9	96.9	0.8
NSA43-4A-2RS	96.9	290.7	1.02
NSA43-4A-2Z	96.9	290.7	1.02
NSA43-4B-2RS	290.7	96.9	1.02
NSA43-4B-2Z	290.7	96.9	1.02
NSA43-5-2RS	290.7	290.7	1.24
NSA43-5-2Z	290.7	290.7	1.24
NSA43-6A-2RS	290.7	484.5	1.47
NSA43-6A-2Z	290.7	484.5	1.47
NSA43-6B-2RS	484.5	290.7	1.47

Designation	Mzd (Nm)	Mzs (Nm)	Weight (kg)
NSA43-6B-2Z	484.5	290.7	1.47
NSW63-3-2ZR	367	367	2.44
NSW63-4A-2ZR	367	1100	3.17
NSW63-4B-2ZR	1100	367	3.17
NSW63-5-2ZR	1100	1100	3.89
NSW63-6A-2ZR	1100	1830	4.60
NSW63-6B-2ZR	1830	1100	4.60
NSA63-3-2ZR	335	335	2.44
NSA63-4A-2ZR	335	935	3.17
NSA63-4B-2ZR	935	335	3.17
NSA63-5-2ZR	935	935	3.89
NSA63-6A-2ZR	935	1560	4.60
NSA63-6B-2ZR	1560	935	4.60

Rail/Slider Combination

T-rail with NSW slider

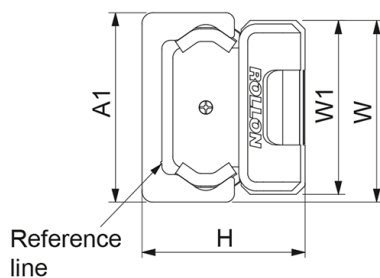

U-rail with NSW slider

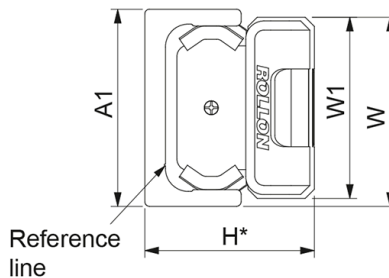

* Nom. value

K-rail with NSA slider

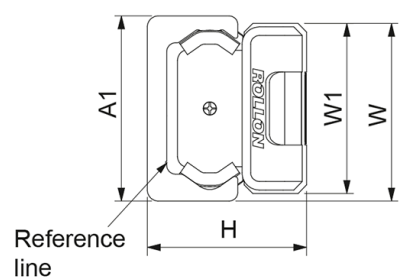

The K-rail enables the slider to twist around its longitudinal axis.

Designation	A1	H (Slider+T-rail)	H (Slider+U-rail)	H (Slider+K-rail)	W1
NSW18-3-2RS	18 (+0.25/-0.10)	16.5 (±0.15)	16,5*	n/a	16 (0/-0.2)
NSW18-3-2Z	18 (+0.25/-0.10)	16.5 (±0.15)	16,5*	n/a	16 (0/-0.2)
NSW18-4A-2RS	18 (+0.25/-0.10)	16.5 (±0.15)	16,5*	n/a	16 (0/-0.2)
NSW18-4A-2Z	18 (+0.25/-0.10)	16.5 (±0.15)	16,5*	n/a	16 (0/-0.2)
NSW18-4B-2RS	18 (+0.25/-0.10)	16.5 (±0.15)	16,5*	n/a	16 (0/-0.2)
NSW18-4B-2Z	18 (+0.25/-0.10)	16.5 (±0.15)	16,5*	n/a	16 (0/-0.2)
NSW18-5-2RS	18 (+0.25/-0.10)	16.5 (±0.15)	16,5*	n/a	16 (0/-0.2)
NSW18-5-2Z	18 (+0.25/-0.10)	16.5 (±0.15)	16,5*	n/a	16 (0/-0.2)
NSW18-6A-2RS	18 (+0.25/-0.10)	16.5 (±0.15)	16,5*	n/a	16 (0/-0.2)
NSW18-6A-2Z	18 (+0.25/-0.10)	16.5 (±0.15)	16,5*	n/a	16 (0/-0.2)
NSW18-6B-2RS	18 (+0.25/-0.10)	16.5 (±0.15)	16,5*	n/a	16 (0/-0.2)
NSW18-6B-2Z	18 (+0.25/-0.10)	16.5 (±0.15)	16,5*	n/a	16 (0/-0.2)
NSW28-3-2RS	28 (+0.25/-0.10)	23.9 (±0.15)	23.9*	n/a	24.9 (0/-0.2)
NSW28-3-2Z	28 (+0.25/-0.10)	23.9 (±0.15)	23.9*	n/a	24.9 (0/-0.2)
NSW28-4A-2RS	28 (+0.25/-0.10)	23.9 (±0.15)	23.9*	n/a	24.9 (0/-0.2)
NSW28-4A-2Z	28 (+0.25/-0.10)	23.9 (±0.15)	23.9*	n/a	24.9 (0/-0.2)
NSW28-4B-2RS	28 (+0.25/-0.10)	23.9 (±0.15)	23.9*	n/a	24.9 (0/-0.2)

Designation	A1	H (Slider+T-rail)	H (Slider+U-rail)	H (Slider+K-rail)	W1
NSW28-4B-2Z	28 (+0.25/-0.10)	23.9 (±0.15)	23.9*	n/a	24.9 (0/-0.2)
NSW28-5-2RS	28 (+0.25/-0.10)	23.9 (±0.15)	23.9*	n/a	24.9 (0/-0.2)
NSW28-5-2Z	28 (+0.25/-0.10)	23.9 (±0.15)	23.9*	n/a	24.9 (0/-0.2)
NSW28-6A-2RS	28 (+0.25/-0.10)	23.9 (±0.15)	23.9*	n/a	24.9 (0/-0.2)
NSW28-6A-2Z	28 (+0.25/-0.10)	23.9 (±0.15)	23.9*	n/a	24.9 (0/-0.2)
NSW28-6B-2RS	28 (+0.25/-0.10)	23.9 (±0.15)	23.9*	n/a	24.9 (0/-0.2)
NSW28-6B-2Z	28 (+0.25/-0.10)	23.9 (±0.15)	23.9*	n/a	24.9 (0/-0.2)
NSW43-3-2RS	43 (+0.35/-0.10)	37 (±0.15)	37*	n/a	39.5 (0/-0.2)
NSW43-3-2Z	43 (+0.35/-0.10)	37 (±0.15)	37*	n/a	39.5 (0/-0.2)
NSW43-4A-2RS	43 (+0.35/-0.10)	37 (±0.15)	37*	n/a	39.5 (0/-0.2)
NSW43-4A-2Z	43 (+0.35/-0.10)	37 (±0.15)	37*	n/a	39.5 (0/-0.2)
NSW43-4B-2RS	43 (+0.35/-0.10)	37 (±0.15)	37*	n/a	39.5 (0/-0.2)
NSW43-4B-2Z	43 (+0.35/-0.10)	37 (±0.15)	37*	n/a	39.5 (0/-0.2)
NSW43-5-2RS	43 (+0.35/-0.10)	37 (±0.15)	37*	n/a	39.5 (0/-0.2)
NSW43-5-2Z	43 (+0.35/-0.10)	37 (±0.15)	37*	n/a	39.5 (0/-0.2)
NSW43-6A-2RS	43 (+0.35/-0.10)	37 (±0.15)	37*	n/a	39.5 (0/-0.2)
NSW43-6A-2Z	43 (+0.35/-0.10)	37 (±0.15)	37*	n/a	39.5 (0/-0.2)
NSW43-6B-2RS	43 (+0.35/-0.10)	37 (±0.15)	37*	n/a	39.5 (0/-0.2)
NSW43-6B-2Z	43 (+0.35/-0.10)	37 (±0.15)	37*	n/a	39.5 (0/-0.2)
NSA43-3-2RS	43 (+0.35/-0.10)	n/a	n/a	37 (±0.15)	39.5 (0/-0.2)
NSA43-3-2Z	43 (+0.35/-0.10)	n/a	n/a	37 (±0.15)	39.5 (0/-0.2)
NSA43-4A-2RS	43 (+0.35/-0.10)	n/a	n/a	37 (±0.15)	39.5 (0/-0.2)
NSA43-4A-2Z	43 (+0.35/-0.10)	n/a	n/a	37 (±0.15)	39.5 (0/-0.2)
NSA43-4B-2RS	43 (+0.35/-0.10)	n/a	n/a	37 (±0.15)	39.5 (0/-0.2)
NSA43-4B-2Z	43 (+0.35/-0.10)	n/a	n/a	37 (±0.15)	39.5 (0/-0.2)
NSA43-5-2RS	43 (+0.35/-0.10)	n/a	n/a	37 (±0.15)	39.5 (0/-0.2)
NSA43-5-2Z	43 (+0.35/-0.10)	n/a	n/a	37 (±0.15)	39.5 (0/-0.2)
NSA43-6A-2RS	43 (+0.35/-0.10)	n/a	n/a	37 (±0.15)	39.5 (0/-0.2)
NSA43-6A-2Z	43 (+0.35/-0.10)	n/a	n/a	37 (±0.15)	39.5 (0/-0.2)
NSA43-6B-2RS	43 (+0.35/-0.10)	n/a	n/a	37 (±0.15)	39.5 (0/-0.2)
NSA43-6B-2Z	43 (+0.35/-0.10)	n/a	n/a	37 (±0.15)	39.5 (0/-0.2)
NSW63-3-2ZR	63 (+0.35/-0.10)	50.5 (±0.15)	50.5*	n/a	60 (0/-0.2)
NSW63-4A-2ZR	63 (+0.35/-0.10)	50.5 (±0.15)	50.5*	n/a	60 (0/-0.2)
NSW63-4B-2ZR	63 (+0.35/-0.10)	50.5 (±0.15)	50.5*	n/a	60 (0/-0.2)
NSW63-5-2ZR	63 (+0.35/-0.10)	50.5 (±0.15)	50.5*	n/a	60 (0/-0.2)
NSW63-6A-2ZR	63 (+0.35/-0.10)	50.5 (±0.15)	50.5*	n/a	60 (0/-0.2)
NSW63-6B-2ZR	63 (+0.35/-0.10)	50.5 (±0.15)	50.5*	n/a	60 (0/-0.2)
NSA63-3-2ZR	63 (+0.35/-0.10)	n/a	n/a	50.5 (±0.15)	60 (0/-0.2)
NSA63-4A-2ZR	63 (+0.35/-0.10)	n/a	n/a	50.5 (±0.15)	60 (0/-0.2)
NSA63-4B-2ZR	63 (+0.35/-0.10)	n/a	n/a	50.5 (±0.15)	60 (0/-0.2)
NSA63-5-2ZR	63 (+0.35/-0.10)	n/a	n/a	50.5 (±0.15)	60 (0/-0.2)
NSA63-6A-2ZR	63 (+0.35/-0.10)	n/a	n/a	50.5 (±0.15)	60 (0/-0.2)
NSA63-6B-2ZR	63 (+0.35/-0.10)	n/a	n/a	50.5 (±0.15)	60 (0/-0.2)

Designation	W
NSW18-3-2RS	17 (+0.1/-0.3)
NSW18-3-2Z	17 (+0.1/-0.3)
NSW18-4A-2RS	17 (+0.1/-0.3)
NSW18-4A-2Z	17 (+0.1/-0.3)
NSW18-4B-2RS	17 (+0.1/-0.3)
NSW18-4B-2Z	17 (+0.1/-0.3)
NSW18-5-2RS	17 (+0.1/-0.3)
NSW18-5-2Z	17 (+0.1/-0.3)
NSW18-6A-2RS	17 (+0.1/-0.3)
NSW18-6A-2Z	17 (+0.1/-0.3)
NSW18-6B-2RS	17 (+0.1/-0.3)
NSW18-6B-2Z	17 (+0.1/-0.3)
NSW28-3-2RS	26.45 (+0.1/-0.3)
NSW28-3-2Z	26.45 (+0.1/-0.3)
NSW28-4A-2RS	26.45 (+0.1/-0.3)
NSW28-4A-2Z	26.45 (+0.1/-0.3)
NSW28-4B-2RS	26.45 (+0.1/-0.3)
NSW28-4B-2Z	26.45 (+0.1/-0.3)
NSW28-5-2RS	26.45 (+0.1/-0.3)
NSW28-5-2Z	26.45 (+0.1/-0.3)
NSW28-6A-2RS	26.45 (+0.1/-0.3)
NSW28-6A-2Z	26.45 (+0.1/-0.3)
NSW28-6B-2RS	26.45 (+0.1/-0.3)
NSW28-6B-2Z	26.45 (+0.1/-0.3)
NSW43-3-2RS	41.25 (+0.2/-0.4)
NSW43-3-2Z	41.25 (+0.2/-0.4)
NSW43-4A-2RS	41.25 (+0.2/-0.4)
NSW43-4A-2Z	41.25 (+0.2/-0.4)
NSW43-4B-2RS	41.25 (+0.2/-0.4)
NSW43-4B-2Z	41.25 (+0.2/-0.4)
NSW43-5-2RS	41.25 (+0.2/-0.4)
NSW43-5-2Z	41.25 (+0.2/-0.4)
NSW43-6A-2RS	41.25 (+0.2/-0.4)
NSW43-6A-2Z	41.25 (+0.2/-0.4)
NSW43-6B-2RS	41.25 (+0.2/-0.4)
NSW43-6B-2Z	41.25 (+0.2/-0.4)
NSA43-3-2RS	41.25 (+0.2/-0.4)
NSA43-3-2Z	41.25 (+0.2/-0.4)
NSA43-4A-2RS	41.25 (+0.2/-0.4)
NSA43-4A-2Z	41.25 (+0.2/-0.4)
NSA43-4B-2RS	41.25 (+0.2/-0.4)
NSA43-4B-2Z	41.25 (+0.2/-0.4)
NSA43-5-2RS	41.25 (+0.2/-0.4)
NSA43-5-2Z	41.25 (+0.2/-0.4)
NSA43-6A-2RS	41.25 (+0.2/-0.4)

Designation	W
NSA43-6A-2Z	41.25 (+0.2/-0.4)
NSA43-6B-2RS	41.25 (+0.2/-0.4)
NSA43-6B-2Z	41.25 (+0.2/-0.4)
NSW63-3-2ZR	61.5 (+0.2/-0.4)
NSW63-4A-2ZR	61.5 (+0.2/-0.4)
NSW63-4B-2ZR	61.5 (+0.2/-0.4)
NSW63-5-2ZR	61.5 (+0.2/-0.4)
NSW63-6A-2ZR	61.5 (+0.2/-0.4)
NSW63-6B-2ZR	61.5 (+0.2/-0.4)
NSA63-3-2ZR	61.5 (+0.2/-0.4)
NSA63-4A-2ZR	61.5 (+0.2/-0.4)
NSA63-4B-2ZR	61.5 (+0.2/-0.4)
NSA63-5-2ZR	61.5 (+0.2/-0.4)
NSA63-6A-2ZR	61.5 (+0.2/-0.4)
NSA63-6B-2ZR	61.5 (+0.2/-0.4)