

Linear Unit MTJZ 110

The MTJZ series contains Z-axis linear units with toothed belt drive, integrated ball rail system and compact dimensions. This linear units provide high performance features such as, high speed, good accuracy and repeatability by vertical applications.

In the linear units MTJZ is used a pre-tensioned steel reinforced AT polyurethane timing toothed belt. In conjunction with a zero-backlash drive pulley high moments with alternating loads with good positioning accuracy, low wear and low noise can be realized.

The in the profile slot driving timing belt protects all the parts in the profile from dust and other contaminations. The drive block provides the possibility to attach a motor or gearbox housing and additional accessories on it.

For CAD-files please contact Rollco.

Dimensions in mm.

Modulus of Elasticity: $E = 70000 \text{ N / mm}^2$

Operating Temperature (°C): 0 ~ +60 For operating temperature out of the presented range, please contact Rollco.

Duty Cycle: 100%

Max. Acceleration (m/s²): 70

Max. Travel Speed (m/s): 5

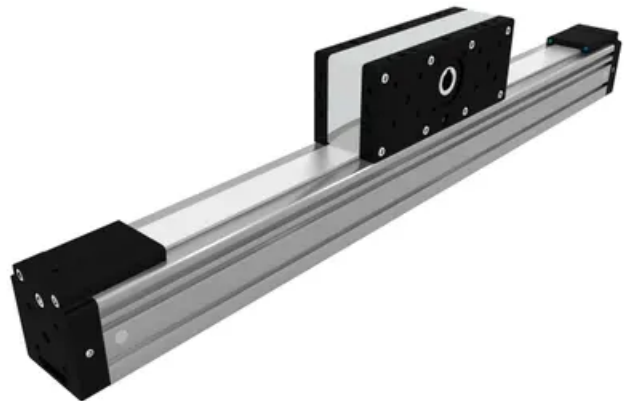

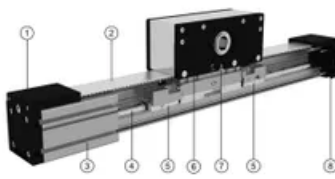

1. Tension End with integrated belt tensioning system
2. AZ polyurethane footed belt with steel tension cords
3. Aluminum profile - hard anodized
4. Linear ball guideway
5. Clamping and braking element for linear guideway
6. Drive block with pulley Motor flange with built in magnets
7. Central lubrication port, both sides
8. Tension end with integrated belt tensioning system

Deflection of the linear unit

MTJZ

Fixed - fixed mounting

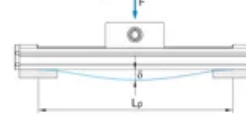

Fixed - free mounting

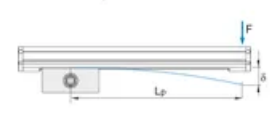

- δ: Maximum deflection of the linear unit [mm]
- δmax: Maximum permissible deflection of the linear unit [mm]
- F: Applied force [N]
- L₀: Unsupported profile length [mm]

The maximum permissible deflection δmax must not be exceeded. In the case that maximum deflection δ exceeds the maximum permissible deflection δmax additional profile supports are needed.

Deflection of the linear unit

MTJZ 110

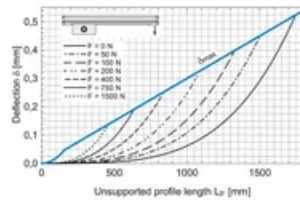
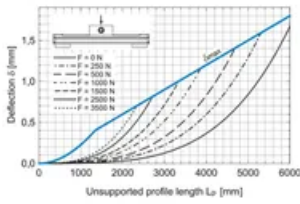

① The linear units do not include any safety stroke.
Absolute stroke = Effective stroke + 2 x safety stroke.

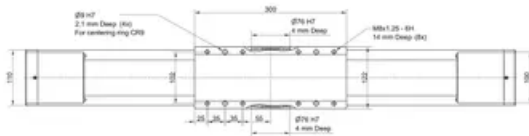

① All dimensions in mm. Drawings scales are not equal.

① The linear units do not include any safety stroke.
Absolute stroke = Effective stroke + 2 x safety stroke.

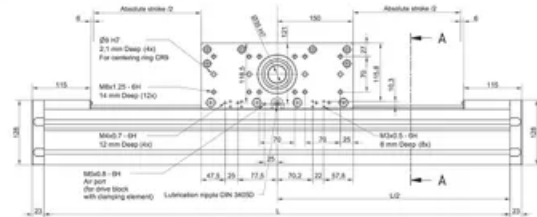

① All dimensions in mm. Drawings scales are not equal.

TYPE 0

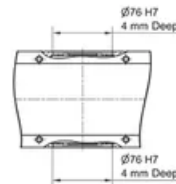

Drive block with clamping element

Clamping by spring-loaded energy

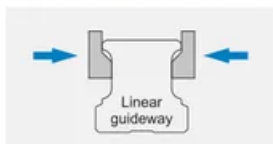

Air pressure = 0 bar

Holding force = 1400 N

Holding force is tested on clamping element using a slightly lubricated rail (ISO VG 68).

Opened by air pressure

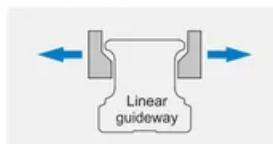

Opening air pressure = 5,5 - 8 bar

The air pressure opens clamping pistons. Free movement is allowed. Purified and oiled air shall be used (according to ISO 8573-1 Class 4). Recommended filter size is 25µm.

Linear Unit	Mass of drive block (kg)	Mass of linear unit (kg)
MTJZ 110	12,9	23,3 + 0,0147 * Stroke (mm)

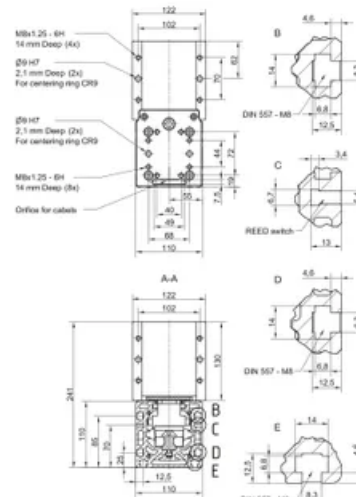

① All dimensions in mm. Drawings scales are not equal.

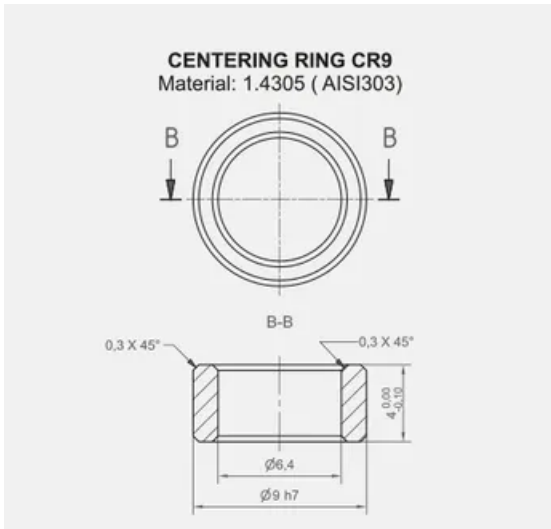

Defining of the linear unit length

$L = \text{Effective stroke} + 2 \times \text{Safety stroke} + 496 \text{ mm}$
 $L_{\text{total}} = L + 46 \text{ mm}$

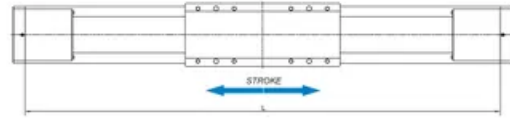

Multi drive block

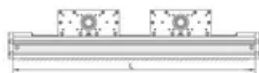

$L = \text{Effective stroke} + 2 \times \text{Safety stroke} + 300 \times n_b + 196 \text{ mm}$ n_b - number of drive blocks
 $L_{\text{total}} = L + 46 \text{ mm}$

General Data

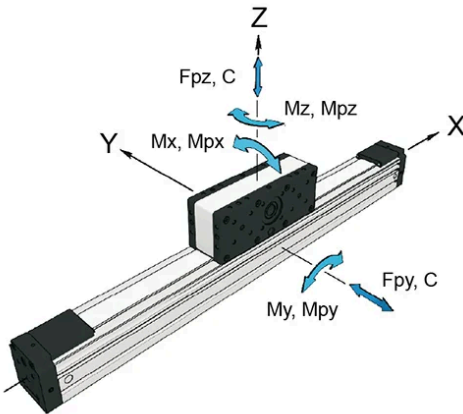

For minimum stroke below the stated value, please contact Rollco.

For length/stroke over the stated value, please contact Rollco. Values for max. stroke are not valid for multi drive box (equation of defining the linear unit length for particular size of the linear unit needs to be used).

Recommended values of loads

All the data of static and dynamic moments and load capacities stated are theoretical without considering any safety factor. The safety factor depends on the application and its requested safety. We recommend a minimum safety factor ($f_s = 5.0$).

Version 1: Mounting by the drive block, profile travels

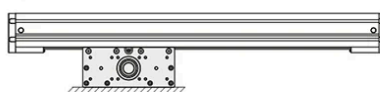

Version 2: Mounting by the profile, drive block travels

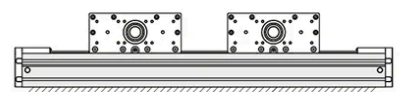

On request, multi drive blocks, which travel independently of each other, can be applied.

Designation	Dynamic Load Capacity C (N)	Static Load Capacity C0 (N)	Dynamic Moment Mx (Nm)	Dynamic Moment My (Nm)	Dynamic Moment Mz (Nm)
MTJZ 110	49600	85000	630	3470	3470

Designation	Mass of Drive Block (kg)	Max. Permissible Loads Forces Fpy (N)	Max. Permissible Loads Forces Fpz (N)	Max. Permissible Loads Moments Mpx (Nm)	Max. Permissible Loads Moments Mpy (Nm)	Max. Permissible Loads Moments Mpz (Nm)
MTJZ 110	11.3	10000	14290	260	1000	700

Designation	Max. Repeatability (mm)	Max. Length Version 1 Lmax (mm)	Max. Length Version 2 Lmax (mm)	Max. Stroke Version 1 (mm)	Max. Stroke Version 2 (mm)	Min. Stroke (mm)
MTJZ 110	± 0.08	1800	6000	1304	5504	65

Drive Data



Max. acceleration (m/s²): 70*

For acceleration over the stated value, please contact Rollco.

Version 1: Mounting by the drive block, profile travels

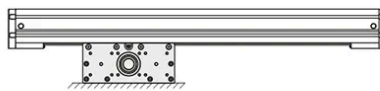

Version 2: Mounting by the profile, drive block travels

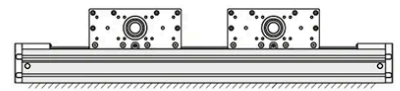

On request, multi drive blocks, which travel independently of each other, can be applied.

Designation	Max. Drive Torque (Nm)	Pulley Drive Ratio (mm/rev)	Pulley Diameter	Planar Moment of Inertia Iy (cm ⁴)	Planar Moment of Inertia Iz (cm ⁴)
MTJZ 110	110	300	95.49	513	620

Designation	Belt Type	Belt Width	Max. Force Transmitted by Belt (N)	Specific Spring Constant Cspec (N)
MTJZ 110	AT10	70	2300	2450000

Mass and Mass Moment



Mass calculation does not include mass of motor, reduction gear, switches and clamps.

Version 1: Mounting by the drive block, profile travels

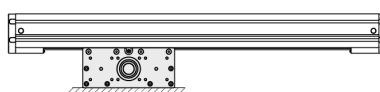

Version 2: Mounting by the profile, drive block travels

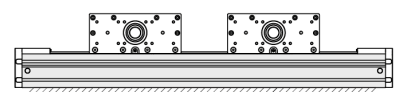

On request, multi drive blocks, which travel independently of each other, can be applied.

Abs. stroke	Absolute stroke [mm]
A	Distance between two drive blocks [mm]
nb	Number of drive blocks

Designation	Mass of Linear Unit (kg)	Mass Moment of Inertia Version 1 (10 ⁻⁴ kg m ²)	Mass Moment of Inertia of Drive Block Version 2 (10 ⁻⁴ kg m ²)	Planar Moment of Inertia Iy (cm ⁴)	Planar Moment of Inertia Iz (cm ⁴)
MTJZ 110	21.7 + 0.0147 × (Abs. Stroke + (nb - 1) × A) + 11.3 × (nb - 1)	282.4 + 0.3358 × (Abs. Stroke + (nb - 1) × A) + 45.3 × (nb - 1)	302.9	513	620