

## Magnetic Field Sensors

Contact Rollco for CAD-files.

Dimensions in mm.

**Ambient Temperature (°C):** -10 ~ +70

**Sensor Type:** GMR sensor

**Switching function:** NC/NO

**Max. Switching Current (mA):** 200x.

**Switching Frequency (Hz):** 1000

**Voltage drop:** 1.5 V / 200 mA max.

**Protection Class:** IP67

**Electrical connection:** M8, 3-pin

**Extension cable:** Energy chain compliant

**Cable material length:** PU - 0.3 m

**Output:** PNP

**Operating Voltage (V DC):** 10 ~ 28

**Max. Power Rating (W):** 5.5 max.

**Current consumption:** 10 mA / 24 V max.

**Shock/vibration:** 50 G / 9 G

**LED indicator:** Yellow



**MTJ / MRJ / MTV**

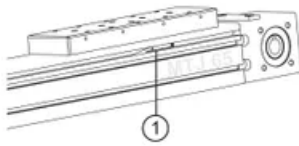

- 1. Magnetic field sensor
- 2. Sensor holder

**CTV / CTJ**

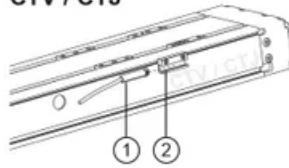





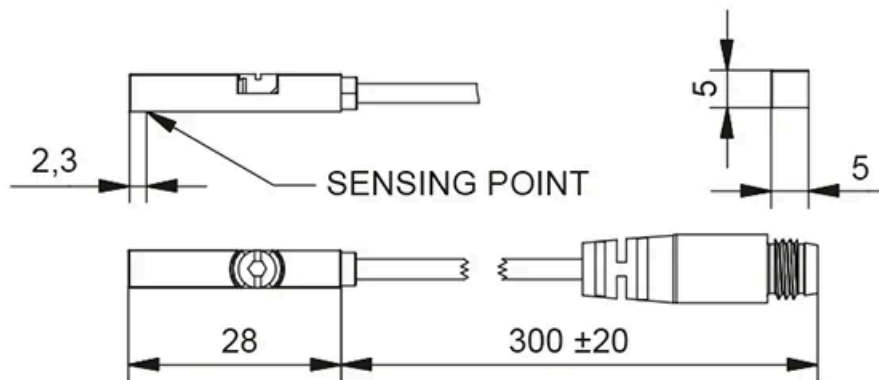



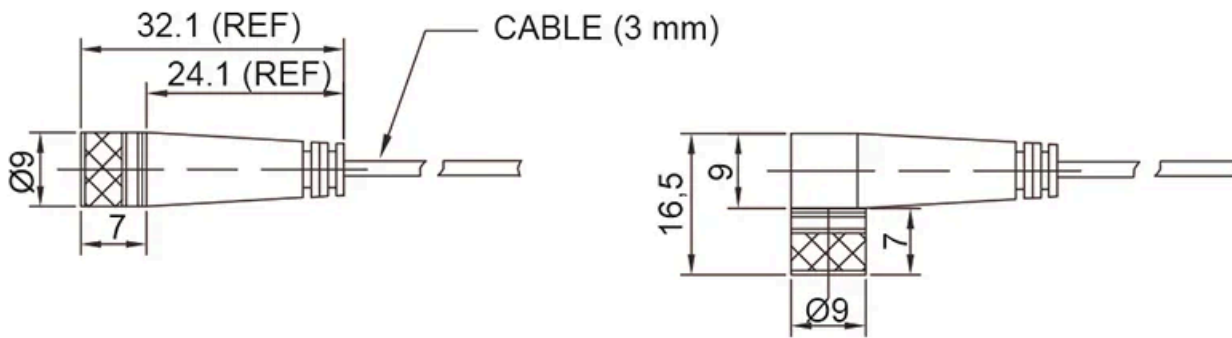

Mounting of magnetic field sensor on CTV and CTJ series requires a HOM sensor holder. For CTV/CTJ 200 a HOM sensor holder is not needed

**General Data**



**Extension cable with connector**



| Type   | Compatibility  |   |
|--|--|---|
| HOM Sensor holder                              | CTV 90, 110, 145<br>CTJ: 90, 110, 145                        |    |
| SMT-65TP-K NC                                  | MTJ / MRJ / MTV / MTJZ:<br>40, 65, 80, 110<br>CTV / CTJ: 200 |    |
| SMT-65TP-K NC+HOM                              | CTV 90, 110, 145<br>CTJ: 90, 110, 145                        |    |
| SMT-65TP-K NO                                  | MTJ / MRJ / MTV / MTJZ:<br>40, 65, 80, 110<br>CTV / CTJ: 200 |    |
| SMT-65TP-K NO+HOM                              | CTV 90, 110, 145<br>CTJ: 90, 110, 145                        |    |
| Extension Cable length 2m - Straight connector |  |    |
| Extension Cable length 5m - Straight connector |  |    |
| Extension Cable length 2m - Angeled connector  |  |   |
| Extension Cable length 5m - Angeled connector  |  |  |

| Designation  | Compatible with                                       |
|--|---|
| HOM Sensor holder - 43851                                | CTV 90, 110, 145CTJ: 90, 110, 145                     |
| SMT-65TP-K NC - 74073                                    | MTJ / MRJ / MTV / MTJZ:40, 65, 80, 110 CTV / CTJ: 200 |
| SMT-65TP-K NC - 77075                                    | CTV 90, 110, 145CTJ: 90, 110, 145                     |
| SMT-65TP-K NO - 74074                                    | MTJ / MRJ / MTV / MTJZ:40, 65, 80, 110 CTV / CTJ: 200 |
| SMT-65TP-K NO - 77076                                    | CTV 90, 110, 145CTJ: 90, 110, 145                     |
| Extension Cable length 2m -<br>Straight connector - 8146 | -   |
| Extension Cable length 5m -<br>Straight connector - 8147 | -   |
| Extension Cable length 2m -<br>Angeled connector - 9017  | -   |
| Extension Cable length 5m -<br>Angeled connector - 9019  | -   |